



LIVALIFT
— ASANSÖR —

ÜRÜN KATALOĐU
PRODUCT **CATALOG**

www.livalift.com.tr

HAKKIMIZDA

Sektör içinde saygın bir şekilde mesafe kateden LİVALİFT yılların verdiği tecrübe ile kalitesinden taviz vermeden yaptığı her projede üstün bir performans göstermektedir.

Temin ettiğimiz asansörlerimiz CE ve ISO kalite güvencesinde olup, siz müşterilerimizin isteğine göre yerli ve yabancı malzemeden imal edilmektedir. LİVALİFT ASANSÖR kusursuz hizmet vermeyi amaçlayan ve performans hedeflerine ulaşmak için takım ruhu içinde çalışan personellerden oluşan genç bir kuruluştur.

Can ve mal güvenliğini ilke edinen Livalift Asansör; misyon edindiği kalite ve müşteri güvenine odaklanma ile üretim, montaj ve satış sonrası hizmet kalitesini artırmaya yönelik çalışmalarına da hızla devam etmektedir.

LİVALİFT ASANSÖR deneyimli kadrosu ve müşterilerinden aldığı destekle güven esaslı bir anlayış ekseninde müşteri ihtiyaçlarını karşılamaya devam edecektir.

ABOUT US

LIVALIFT is continuously developing in the industry shows superior performance on each project without compromising the quality with years of experience. The lifts that we have been producing have CE and ISO quality assurance. The lift equipments are manufactured from materials supplied from domestic and/or international suppliers acc. to customer requirements. LIVALIFT is a young organization that aims to provide excellent service and consisting of young employees working with a team spirit to achieve their performance targets.

LIVALIFT Elevator adopts the principle of reaching a safety of life and property by focusing on quality and customer confidence continues rapidly to the missions to increase the quality of production, installation and after-sales service.

LIVALIFT will continue to meet the customer needs with its experienced staff and a trust based understanding with the support that receives from its customers.



spirit customer's organization

LIVALIFT

made installation working
experienced assurance
employees provide
after-sales experience
customers gain project superior
production based continue excellent
principle missions achieve domestic
ground
performance
Elevator staff
years needs
focus customer
young will
rapidly targets
property life
safety trust
service
continues
confidence
adopts ISO
reaching
meet
aims

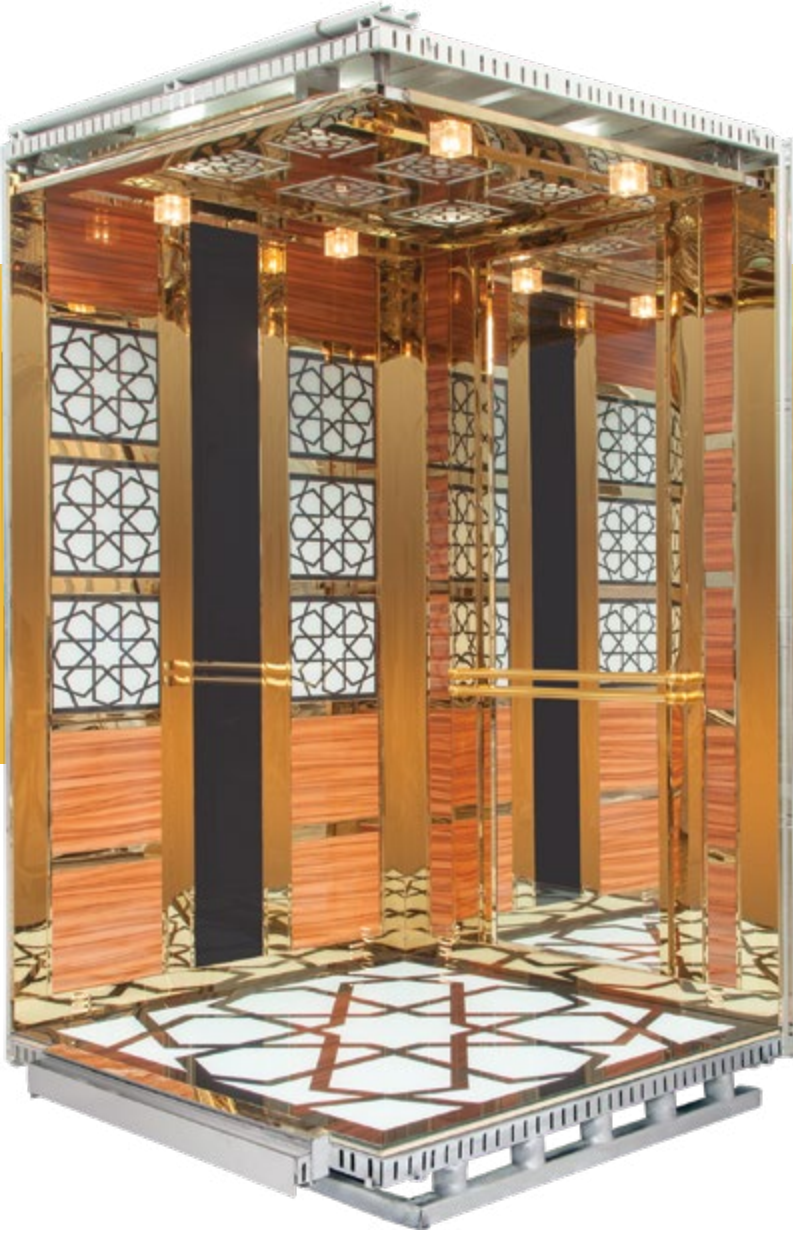

LV1101

Özellikler

- Duvarlar 1,5 mm galvanizli sac
- Laminant kabinler 18 mm radüslü
- Paslanmaz kabinler 304 kalite
- Komple lazer tavan
- Cam kabinlerde farklı renk ve desen uygulamaları
- Cam ve led tavan seçeneği
- PVC anti bakteriyel taban
- 20 mm doğal granit taban seçeneği
- Farklı taban seçenekleri
- Çalıştırılmaya hazır aydınlatma ve fan
- Taban - Tavan - Süspansiyon statik boya
- Tercihe bağlı sandık ambalaj
- Bütün kabinlerimizde kayma fren standartımızdır.

Properties

- The walls are 1.5 mm galvanized sheet
- Laminate cabins with 18 mm Radius
- 304 quality stainless steel cabins
- Complete laser ceiling
- Different colors and designs applications in the glass cabins
- Glass and led ceiling options
- PVC anti-bacterial floor
- 20 mm natural granite base option
- Different base options
- Ready to run lighting and fan
- Floor - Ceiling - Suspension static paint
- Optional case packing
- Slipping brake is a standard in all of our cabins.

LV1102



Özellikler

- Duvarlar 1,5 mm galvanizli sac
- Laminant kabinler 18 mm radüslü
- Paslanmaz kabinler 304 kalite
- Komple lazer tavan
- Cam kabinlerde farklı renk ve desen uygulamaları
- Cam ve led tavan seçeneği
- PVC anti bakteriyel taban
- 20 mm doğal granit taban seçeneği
- Farklı taban seçenekleri
- Çalıştırılmaya hazır aydınlatma ve fan
- Taban - Tavan - Süspansiyon statik boya
- Tercihe bağlı sandık ambalaj
- Bütün kabinlerimizde kayma fren standartımızdır.

Properties

- The walls are 1.5 mm galvanized sheet
- Laminate cabins with 18 mm Radius
- 304 quality stainless steel cabins
- Complete laser ceiling
- Different colors and designs applications in the glass cabins
- Glass and led ceiling options
- PVC anti-bacterial floor
- 20 mm natural granite base option
- Different base options
- Ready to run lighting and fan
- Floor - Ceiling - Suspension static paint
- Optional case packing
- Slipping brake is a standard in all of our cabins.



LV1103

Özellikler

- Duvarlar 1,5 mm galvanizli sac
- Laminant kabinler 18 mm radüslü
- Paslanmaz kabinler 304 kalite
- Komple lazer tavan
- Cam kabinlerde farklı renk ve desen uygulamaları
- Cam ve led tavan seçeneği
- PVC anti bakteriyel taban
- 20 mm doğal granit taban seçeneği
- Farklı taban seçenekleri
- Çalıştırılmaya hazır aydınlatma ve fan
- Taban - Tavan - Süspansiyon statik boya
- Tercihe bağlı sandık ambalaj
- Bütün kabinlerimizde kayma fren standartımızdır.

Properties

- The walls are 1.5 mm galvanized sheet
- Laminate cabins with 18 mm Radius
- 304 quality stainless steel cabins
- Complete laser ceiling
- Different colors and designs applications in the glass cabins
- Glass and led ceiling options
- PVC anti-bacterial floor
- 20 mm natural granite base option
- Different base options
- Ready to run lighting and fan
- Floor - Ceiling - Suspension static paint
- Optional case packing
- Slipping brake is a standard in all of our cabins.

LV1104



Özellikler

- Duvarlar 1,5 mm galvanizli sac
- Laminant kabinler 18 mm radüslü
- Paslanmaz kabinler 304 kalite
- Komple lazer tavan
- Cam kabinlerde farklı renk ve desen uygulamaları
- Cam ve led tavan seçeneği
- PVC anti bakteriyel taban
- 20 mm doğal granit taban seçeneği
- Farklı taban seçenekleri
- Çalıştırılmaya hazır aydınlatma ve fan
- Taban - Tavan - Süspansiyon statik boya
- Tercihe bağlı sandık ambalaj
- Bütün kabinlerimizde kayma fren standartımızdır.

Properties

- The walls are 1.5 mm galvanized sheet
- Laminate cabins with 18 mm Radius
- 304 quality stainless steel cabins
- Complete laser ceiling
- Different colors and designs applications in the glass cabins
- Glass and led ceiling options
- PVC anti-bacterial floor
- 20 mm natural granite base option
- Different base options
- Ready to run lighting and fan
- Floor - Ceiling - Suspension static paint
- Optional case packing
- Slipping brake is a standard in all of our cabins.



LV1105

Özellikler

- Duvarlar 1,5 mm galvanizli sac
- Laminant kabinler 18 mm radüslü
- Paslanmaz kabinler 304 kalite
- Komple lazer tavan
- Cam kabinlerde farklı renk ve desen uygulamaları
- Cam ve led tavan seçeneği
- PVC anti bakteriyel taban
- 20 mm doğal granit taban seçeneği
- Farklı taban seçenekleri
- Çalıştırılmaya hazır aydınlatma ve fan
- Taban - Tavan - Süspansiyon statik boya
- Tercihe bağlı sandık ambalaj
- Bütün kabinlerimizde kayma fren standartımızdır.

Properties

- The walls are 1.5 mm galvanized sheet
- Laminate cabins with 18 mm Radius
- 304 quality stainless steel cabins
- Complete laser ceiling
- Different colors and designs applications in the glass cabins
- Glass and led ceiling options
- PVC anti-bacterial floor
- 20 mm natural granite base option
- Different base options
- Ready to run lighting and fan
- Floor - Ceiling - Suspension static paint
- Optional case packing
- Slipping brake is a standard in all of our cabins.

LV1106

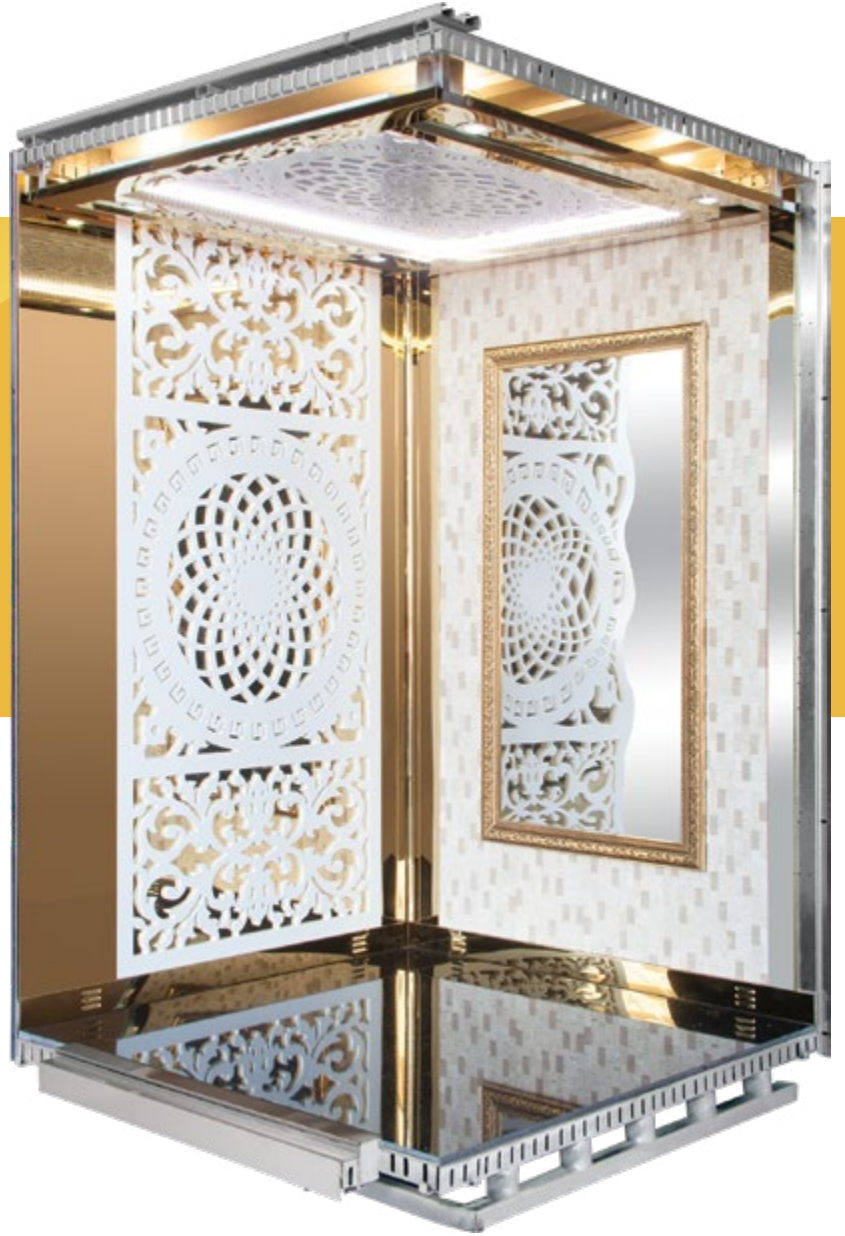

Özellikler

- Duvarlar 1,5 mm galvanizli sac
- Laminant kabinler 18 mm radüslü
- Paslanmaz kabinler 304 kalite
- Komple lazer tavan
- Cam kabinlerde farklı renk ve desen uygulamaları
- Cam ve led tavan seçeneği
- PVC anti bakteriyel taban
- 20 mm doğal granit taban seçeneği
- Farklı taban seçenekleri
- Çalıştırılmaya hazır aydınlatma ve fan
- Taban - Tavan - Süspansiyon statik boya
- Tercihe bağlı sandık ambalaj
- Bütün kabinlerimizde kayma fren standartımızdır.

Properties

- The walls are 1.5 mm galvanized sheet
- Laminate cabins with 18 mm Radius
- 304 quality stainless steel cabins
- Complete laser ceiling
- Different colors and designs applications in the glass cabins
- Glass and led ceiling options
- PVC anti-bacterial floor
- 20 mm natural granite base option
- Different base options
- Ready to run lighting and fan
- Floor - Ceiling - Suspension static paint
- Optional case packing
- Slipping brake is a standard in all of our cabins.

LV2101



Özellikler

- Duvarlar 1,5 mm galvanizli sac
- Laminant kabinler 18 mm radüslü
- Paslanmaz kabinler 304 kalite
- Komple lazer tavan
- Cam kabinlerde farklı renk ve desen uygulamaları
- Cam ve led tavan seçeneği
- PVC anti bakteriyel taban
- 20 mm doğal granit taban seçeneği
- Farklı taban seçenekleri
- Çalıştırılmaya hazır aydınlatma ve fan
- Taban - Tavan - Süspansiyon statik boya
- Tercihe bağlı sandık ambalaj
- Bütün kabinlerimizde kayma fren standartımızdır.

Properties

- The walls are 1.5 mm galvanized sheet
- Laminate cabins with 18 mm Radius
- 304 quality stainless steel cabins
- Complete laser ceiling
- Different colors and designs applications in the glass cabins
- Glass and led ceiling options
- PVC anti-bacterial floor
- 20 mm natural granite base option
- Different base options
- Ready to run lighting and fan
- Floor - Ceiling - Suspension static paint
- Optional case packing
- Slipping brake is a standard in all of our cabins.

LV2102



Özellikler

- Duvarlar 1,5 mm galvanizli sac
- Laminant kabinler 18 mm radüslü
- Paslanmaz kabinler 304 kalite
- Komple lazer tavan
- Cam kabinlerde farklı renk ve desen uygulamaları
- Cam ve led tavan seçeneği
- PVC anti bakteriyel taban
- 20 mm doğal granit taban seçeneği
- Farklı taban seçenekleri
- Çalıştırılmaya hazır aydınlatma ve fan
- Taban - Tavan - Süspansiyon statik boya
- Tercihe bağlı sandık ambalaj
- Bütün kabinlerimizde kayma fren standartımızdır.

Properties

- The walls are 1.5 mm galvanized sheet
- Laminate cabins with 18 mm Radius
- 304 quality stainless steel cabins
- Complete laser ceiling
- Different colors and designs applications in the glass cabins
- Glass and led ceiling options
- PVC anti-bacterial floor
- 20 mm natural granite base option
- Different base options
- Ready to run lighting and fan
- Floor - Ceiling - Suspension static paint
- Optional case packing
- Slipping brake is a standard in all of our cabins.



LV2103

Özellikler

- Duvarlar 1,5 mm galvanizli sac
- Laminant kabinler 18 mm radüslü
- Paslanmaz kabinler 304 kalite
- Komple lazer tavan
- Cam kabinlerde farklı renk ve desen uygulamaları
- Cam ve led tavan seçeneği
- PVC anti bakteriyel taban
- 20 mm doğal granit taban seçeneği
- Farklı taban seçenekleri
- Çalıştırılmaya hazır aydınlatma ve fan
- Taban - Tavan - Süspansiyon statik boya
- Tercihe bağlı sandık ambalaj
- Bütün kabinlerimizde kayma fren standartımızdır.

Properties

- The walls are 1.5 mm galvanized sheet
- Laminate cabins with 18 mm Radius
- 304 quality stainless steel cabins
- Complete laser ceiling
- Different colors and designs applications in the glass cabins
- Glass and led ceiling options
- PVC anti-bacterial floor
- 20 mm natural granite base option
- Different base options
- Ready to run lighting and fan
- Floor - Ceiling - Suspension static paint
- Optional case packing
- Slipping brake is a standard in all of our cabins.

LV2104



Özellikler

- Duvarlar 1,5 mm galvanizli sac
- Laminant kabinler 18 mm radüslü
- Paslanmaz kabinler 304 kalite
- Komple lazer tavan
- Cam kabinlerde farklı renk ve desen uygulamaları
- Cam ve led tavan seçeneği
- PVC anti bakteriyel taban
- 20 mm doğal granit taban seçeneği
- Farklı taban seçenekleri
- Çalıştırılmaya hazır aydınlatma ve fan
- Taban - Tavan - Süspansiyon statik boya
- Tercihe bağlı sandık ambalaj
- Bütün kabinlerimizde kayma fren standartımızdır.

Properties

- The walls are 1.5 mm galvanized sheet
- Laminate cabins with 18 mm Radius
- 304 quality stainless steel cabins
- Complete laser ceiling
- Different colors and designs applications in the glass cabins
- Glass and led ceiling options
- PVC anti-bacterial floor
- 20 mm natural granite base option
- Different base options
- Ready to run lighting and fan
- Floor - Ceiling - Suspension static paint
- Optional case packing
- Slipping brake is a standard in all of our cabins.



LV2105

Özellikler

- Duvarlar 1,5 mm galvanizli sac
- Laminant kabinler 18 mm radüslü
- Paslanmaz kabinler 304 kalite
- Komple lazer tavan
- Cam kabinlerde farklı renk ve desen uygulamaları
- Cam ve led tavan seçeneği
- PVC anti bakteriyel taban
- 20 mm doğal granit taban seçeneği
- Farklı taban seçenekleri
- Çalıştırılmaya hazır aydınlatma ve fan
- Taban - Tavan - Süspansiyon statik boya
- Tercihe bağlı sandık ambalaj
- Bütün kabinlerimizde kayma fren standartımızdır.

Properties

- The walls are 1.5 mm galvanized sheet
- Laminate cabins with 18 mm Radius
- 304 quality stainless steel cabins
- Complete laser ceiling
- Different colors and designs applications in the glass cabins
- Glass and led ceiling options
- PVC anti-bacterial floor
- 20 mm natural granite base option
- Different base options
- Ready to run lighting and fan
- Floor - Ceiling - Suspension static paint
- Optional case packing
- Slipping brake is a standard in all of our cabins.

LV2106



Özellikler

- Duvarlar 1,5 mm galvanizli sac
- Laminant kabinler 18 mm radüslü
- Paslanmaz kabinler 304 kalite
- Komple lazer tavan
- Cam kabinlerde farklı renk ve desen uygulamaları
- Cam ve led tavan seçeneği
- PVC anti bakteriyel taban
- 20 mm doğal granit taban seçeneği
- Farklı taban seçenekleri
- Çalıştırılmaya hazır aydınlatma ve fan
- Taban - Tavan - Süspansiyon statik boya
- Tercihe bağlı sandık ambalaj
- Bütün kabinlerimizde kayma fren standartımızdır.

Properties

- The walls are 1.5 mm galvanized sheet
- Laminate cabins with 18 mm Radius
- 304 quality stainless steel cabins
- Complete laser ceiling
- Different colors and designs applications in the glass cabins
- Glass and led ceiling options
- PVC anti-bacterial floor
- 20 mm natural granite base option
- Different base options
- Ready to run lighting and fan
- Floor - Ceiling - Suspension static paint
- Optional case packing
- Slipping brake is a standard in all of our cabins.



LV2107

Özellikler

- Duvarlar 1,5 mm galvanizli sac
- Laminant kabinler 18 mm radüslü
- Paslanmaz kabinler 304 kalite
- Komple lazer tavan
- Cam kabinlerde farklı renk ve desen uygulamaları
- Cam ve led tavan seçeneği
- PVC anti bakteriyel taban
- 20 mm doğal granit taban seçeneği
- Farklı taban seçenekleri
- Çalıştırılmaya hazır aydınlatma ve fan
- Taban - Tavan - Süspansiyon statik boya
- Tercihe bağlı sandık ambalaj
- Bütün kabinlerimizde kayma fren standartımızdır.

Properties

- The walls are 1.5 mm galvanized sheet
- Laminate cabins with 18 mm Radius
- 304 quality stainless steel cabins
- Complete laser ceiling
- Different colors and designs applications in the glass cabins
- Glass and led ceiling options
- PVC anti-bacterial floor
- 20 mm natural granite base option
- Different base options
- Ready to run lighting and fan
- Floor - Ceiling - Suspension static paint
- Optional case packing
- Slipping brake is a standard in all of our cabins.

LV2108



Özellikler

- Duvarlar 1,5 mm galvanizli sac
- Laminant kabinler 18 mm radüslü
- Paslanmaz kabinler 304 kalite
- Komple lazer tavan
- Cam kabinlerde farklı renk ve desen uygulamaları
- Cam ve led tavan seçeneği
- PVC anti bakteriyel taban
- 20 mm doğal granit taban seçeneği
- Farklı taban seçenekleri
- Çalıştırılmaya hazır aydınlatma ve fan
- Taban - Tavan - Süspansiyon statik boya
- Tercihe bağlı sandık ambalaj
- Bütün kabinlerimizde kayma fren standartımızdır.

Properties

- The walls are 1.5 mm galvanized sheet
- Laminate cabins with 18 mm Radius
- 304 quality stainless steel cabins
- Complete laser ceiling
- Different colors and designs applications in the glass cabins
- Glass and led ceiling options
- PVC anti-bacterial floor
- 20 mm natural granite base option
- Different base options
- Ready to run lighting and fan
- Floor - Ceiling - Suspension static paint
- Optional case packing
- Slipping brake is a standard in all of our cabins.



LV3102

Özellikler

- Duvarlar 1,5 mm galvanizli sac
- Laminant kabinler 18 mm radüslü
- Paslanmaz kabinler 304 kalite
- Komple lazer tavan
- Cam kabinlerde farklı renk ve desen uygulamaları
- Cam ve led tavan seçeneği
- PVC anti bakteriyel taban
- 20 mm doğal granit taban seçeneği
- Farklı taban seçenekleri
- Çalıştırılmaya hazır aydınlatma ve fan
- Taban - Tavan - Süspansiyon statik boya
- Tercihe bağlı sandık ambalaj
- Bütün kabinlerimizde kayma fren standartımızdır.

Properties

- The walls are 1.5 mm galvanized sheet
- Laminate cabins with 18 mm Radius
- 304 quality stainless steel cabins
- Complete laser ceiling
- Different colors and designs applications in the glass cabins
- Glass and led ceiling options
- PVC anti-bacterial floor
- 20 mm natural granite base option
- Different base options
- Ready to run lighting and fan
- Floor - Ceiling - Suspension static paint
- Optional case packing
- Slipping brake is a standard in all of our cabins.

LV3103



Özellikler

- Duvarlar 1,5 mm galvanizli sac
- Laminant kabinler 18 mm radüslü
- Paslanmaz kabinler 304 kalite
- Komple lazer tavan
- Cam kabinlerde farklı renk ve desen uygulamaları
- Cam ve led tavan seçeneği
- PVC anti bakteriyel taban
- 20 mm doğal granit taban seçeneği
- Farklı taban seçenekleri
- Çalıştırılmaya hazır aydınlatma ve fan
- Taban - Tavan - Süspansiyon statik boya
- Tercihe bağlı sandık ambalaj
- Bütün kabinlerimizde kayma fren standartımızdır.

Properties

- The walls are 1.5 mm galvanized sheet
- Laminate cabins with 18 mm Radius
- 304 quality stainless steel cabins
- Complete laser ceiling
- Different colors and designs applications in the glass cabins
- Glass and led ceiling options
- PVC anti-bacterial floor
- 20 mm natural granite base option
- Different base options
- Ready to run lighting and fan
- Floor - Ceiling - Suspension static paint
- Optional case packing
- Slipping brake is a standard in all of our cabins.



LV3101

Özellikler

- Duvarlar 1,5 mm galvanizli sac
- Laminant kabinler 18 mm radüslü
- Paslanmaz kabinler 304 kalite
- Komple lazer tavan
- Cam kabinlerde farklı renk ve desen uygulamaları
- Cam ve led tavan seçeneği
- PVC anti bakteriyel taban
- 20 mm doğal granit taban seçeneği
- Farklı taban seçenekleri
- Çalıştırılmaya hazır aydınlatma ve fan
- Taban - Tavan - Süspansiyon statik boya
- Tercihe bağlı sandık ambalaj
- Bütün kabinlerimizde kayma fren standartımızdır.

Properties

- The walls are 1.5 mm galvanized sheet
- Laminate cabins with 18 mm Radius
- 304 quality stainless steel cabins
- Complete laser ceiling
- Different colors and designs applications in the glass cabins
- Glass and led ceiling options
- PVC anti-bacterial floor
- 20 mm natural granite base option
- Different base options
- Ready to run lighting and fan
- Floor - Ceiling - Suspension static paint
- Optional case packing
- Slipping brake is a standard in all of our cabins.

LV4101



Özellikler

- Duvarlar 1,5 mm galvanizli sac
- Laminant kabinler 18 mm radüslü
- Paslanmaz kabinler 304 kalite
- Komple lazer tavan
- Cam kabinlerde farklı renk ve desen uygulamaları
- Cam ve led tavan seçeneği
- PVC anti bakteriyel taban
- 20 mm doğal granit taban seçeneği
- Farklı taban seçenekleri
- Çalıştırılmaya hazır aydınlatma ve fan
- Taban - Tavan - Süspansiyon statik boya
- Tercihe bağlı sandık ambalaj
- Bütün kabinlerimizde kayma fren standartımızdır.

Properties

- The walls are 1.5 mm galvanized sheet
- Laminate cabins with 18 mm Radius
- 304 quality stainless steel cabins
- Complete laser ceiling
- Different colors and designs applications in the glass cabins
- Glass and led ceiling options
- PVC anti-bacterial floor
- 20 mm natural granite base option
- Different base options
- Ready to run lighting and fan
- Floor - Ceiling - Suspension static paint
- Optional case packing
- Slipping brake is a standard in all of our cabins.



LV5101

Özellikler

- Duvarlar 1,5 mm galvanizli sac
- Laminant kabinler 18 mm radüslü
- Paslanmaz kabinler 304 kalite
- Komple lazer tavan
- Cam kabinlerde farklı renk ve desen uygulamaları
- Cam ve led tavan seçeneği
- PVC anti bakteriyel taban
- 20 mm doğal granit taban seçeneği
- Farklı taban seçenekleri
- Çalıştırılmaya hazır aydınlatma ve fan
- Taban - Tavan - Süspansiyon statik boya
- Tercihe bağlı sandık ambalaj
- Bütün kabinlerimizde kayma fren standartımızdır.

Properties

- The walls are 1.5 mm galvanized sheet
- Laminate cabins with 18 mm Radius
- 304 quality stainless steel cabins
- Complete laser ceiling
- Different colors and designs applications in the glass cabins
- Glass and led ceiling options
- PVC anti-bacterial floor
- 20 mm natural granite base option
- Different base options
- Ready to run lighting and fan
- Floor - Ceiling - Suspension static paint
- Optional case packing
- Slipping brake is a standard in all of our cabins.



LV-D01

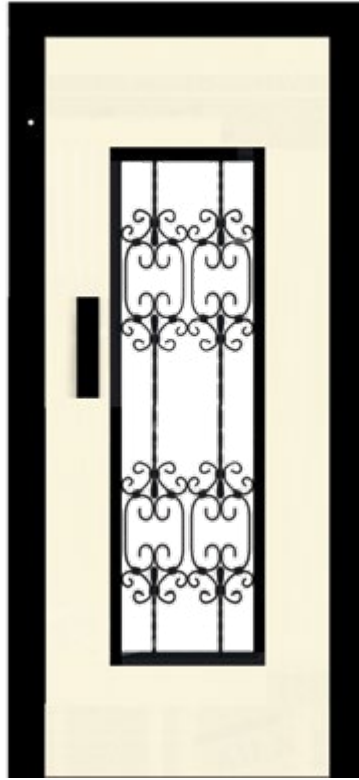

LV-D02

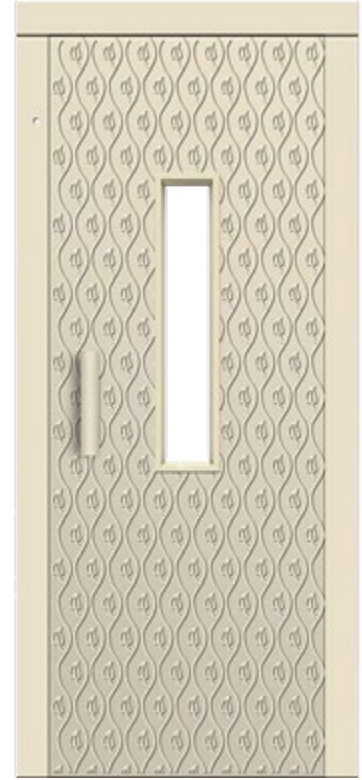

LV-D03



LV-D04



LV-D05

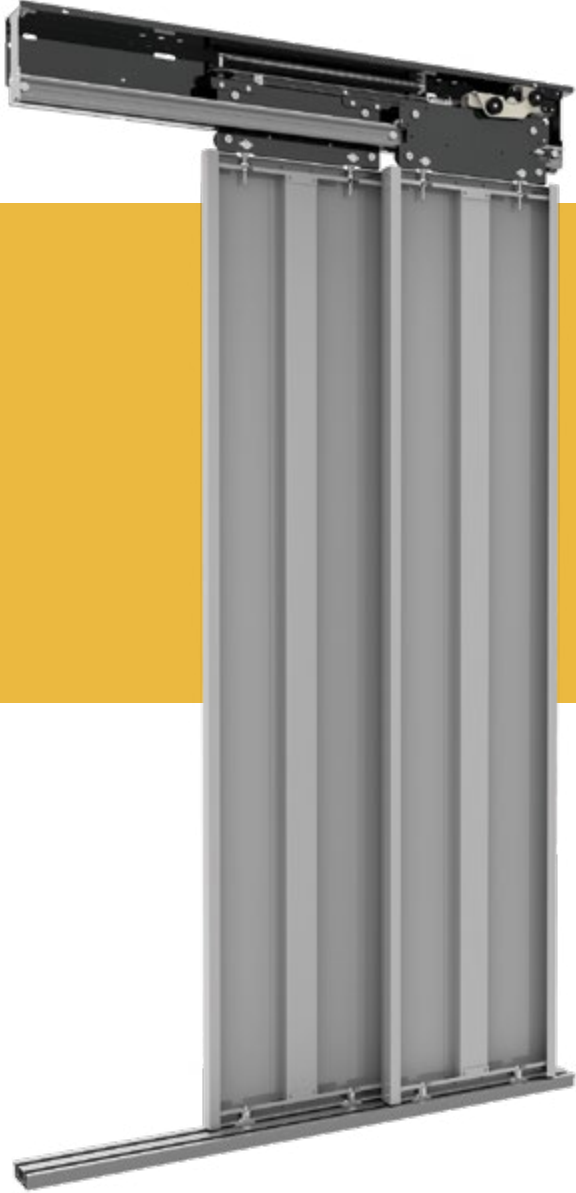

Teleskopik 2 Panel Kat Kapısı

Telescopic 2 Panel Landing Door

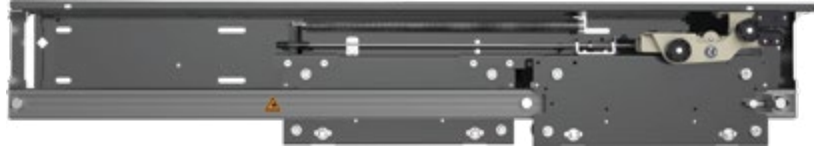

Özellikler

- CE li kilit sistemi
- Modüler montaj ve satışı
- Referans işaretleri ile kolay montaj
- Mekanizmanın pozisyon ayarı
- Panellerin üç eksende ayarı
- Kilit sisteminin ayarı
- Yay sertlik ayarı

Properties

- CE locking system
- Modular installation and sales
- Easy installation with reference mark
- Mechanism position adjustment
- Panel adjustment in three axes
- Adjustment position for locking
- Spring force adjustment

Teleskopik 2 Panel Kabin Kapısı

Telescopic 2 Panel Cabin Door

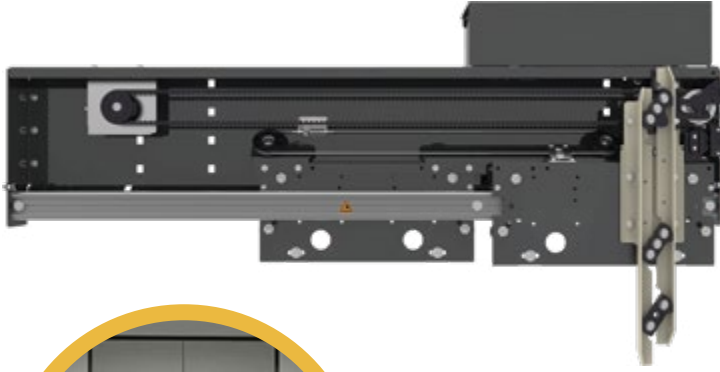
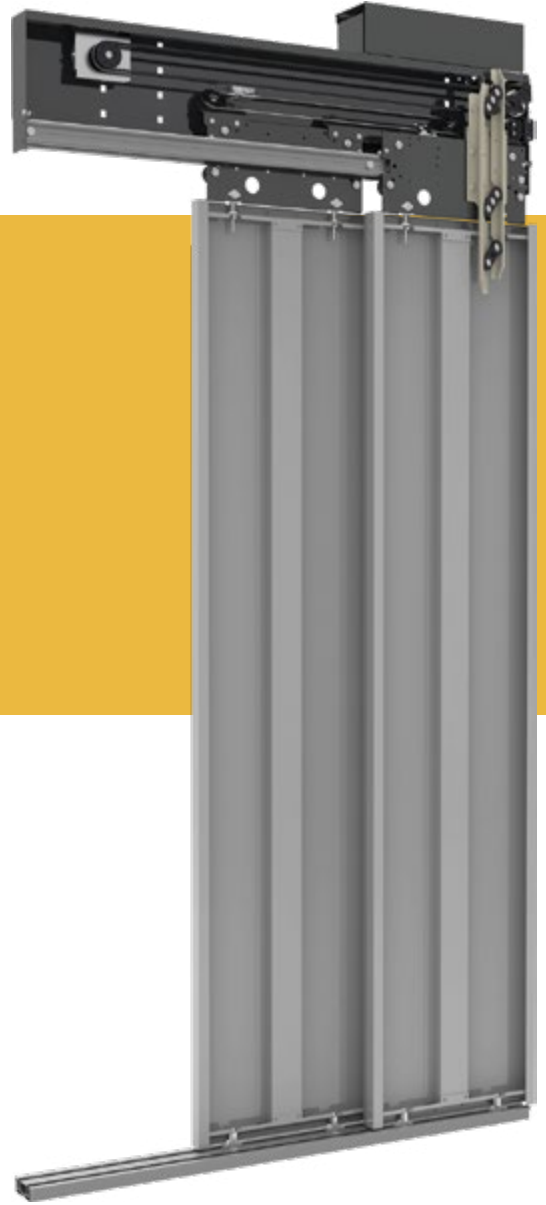

Özellikler

- Modüler montaj ve satışı
- Panellerin üç eksende ayarı
- Giriş Geniřlięi Ayarı
- 220 V AC ve 115 V AC Besleme Gerilimi
- Çift Kanal 100 Puls Enkoder
- İsteęe Baęlı Sürücü Seçenekleri;
- 24 V DC motorlar ve sürücüler (Redüktörlü)
- 220 V AC motorlar ve sürücüler (Redüktörsüz)

Properties

- Easy installation
- Panel adjustment in three axes
- Entry width adjustment
- 220V AC and 115V AC supply voltage
- 100 pulse dual channel encoder
- Optional driver options ;
- 24V DC motors and drivers (with reductor)
- 220V AC motors and drivers (without reductor)



Merkezi 2 Panel Kat Kapısı Central 2 Panel Landing Door



Özellikler

- CE li kilit sistemi
- Modüler montaj ve satışı
- Referans işaretleri ile kolay montaj
- Mekanizmanın pozisyon ayarı
- Panellerin üç eksende ayarı
- Kilit sisteminin ayarı
- Yay sertlik ayarı

Properties

- CE locking system
- Modular installation and sales
- Easy installation with reference mark
- Mechanism position adjustment
- Panel adjustment in three axes
- Adjustment position for locking
- Spring force adjustment

Merkezi 2 Panel Kabin Kapısı

Central 2 Panel Cabin Door

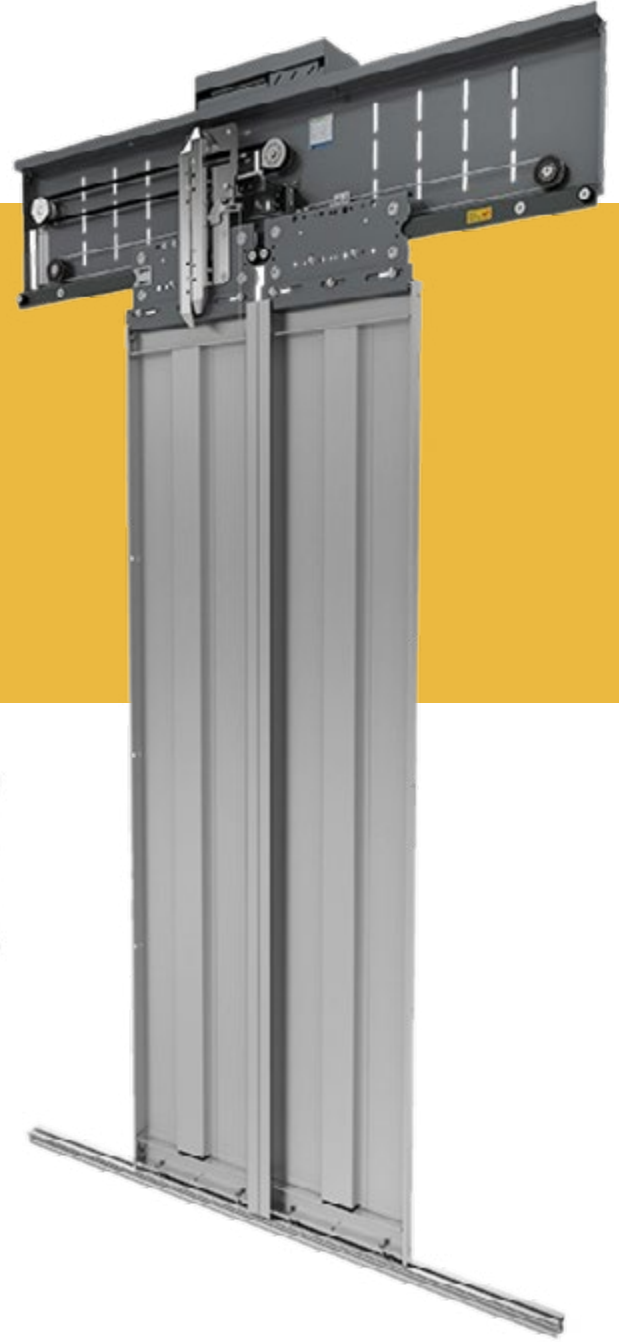
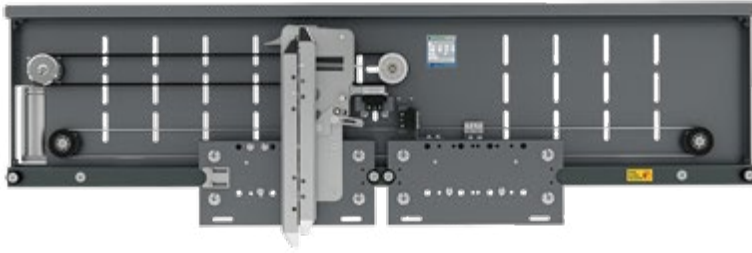

Özellikler

- Modüler montaj ve satışı
- Panellerin üç eksende ayarı
- Giriş Genişliği Ayarı
- 220 V AC ve 115 V AC Besleme Gerilimi
- Çift Kanal 100 Puls Enkoder
- İsteğe Bağlı Sürücü Seçenekleri;
- 24 V DC motorlar ve sürücüler (Redüktörlü)
- 220 V AC motorlar ve sürücüler (Redüktörsüz)

Properties

- Easy installation
- Panel adjustment in three axes
- Entry width adjustment
- 220V AC and 115V AC supply voltage
- 100 pulse dual channel encoder
- Optional driver options ;
- 24V DC motors and drivers (with reductor)
- 220V AC motors and drivers (without reductor)

1. Kumanda Panosu
2. Dişli/Dişlisiz Tahrik Makinası
3. Hız Regülatörü
4. Acil Stop Butonu
5. Acil Kurtarma Kapısı Konağı
6. 3 Faz Ana Besleme
7. Paraşüt Fren
8. Revizyon Kutusu
9. Alt ve Üst Tekerlekli Sınır Şalterleri
10. Güvenlik Sensörü
11. Alt ve Üst Sınır Şalterleri
12. Kabin Lambası
13. Kabin Fanı
14. Kabin ve Kabin Kapısı
15. Kabin Butonu
16. Boy Fotosel
17. Fiş/Kilit/Toprak Bağlantı Soketleri
18. Kat Kapıları
19. Kat Kasetleri
20. Kabin / Karşıağırlık Tamponu Konağı
21. Hız Regülatörü Halat Gergisi Konağı
22. Kuyu Dibi Panosu
23. Kuyu Dibi El Kumanda Butonu
24. Interkom Telefonu

1. Lift Control Panel
2. Geared/Gearless Traction Machine
3. Overspeed Governor
4. Emergency Stop Button
5. Emergency Trap Door Contact
6. 3 Phase Main Power Supply
7. Safety Gear
8. Inspection Box
9. Bottom and Top Whell Type Limit Switches
10. Safety Sensor
11. Bottom and Top Limit Switches
12. Cabin Light
13. Cabin Fan
14. Cabin and Cabin Door
15. Cabin Operating Panel
16. Light Curtain
17. Door/Lock/Earth Connection Sockets
18. Landing Doors
19. Landing Operating Panels
20. Cabin/ Counterweight Buffer Contact
21. Ov. Governor Tension Pulley Contact
22. Pit Connection Box
23. Pit Manuel Control Unit
24. Intercon Phone

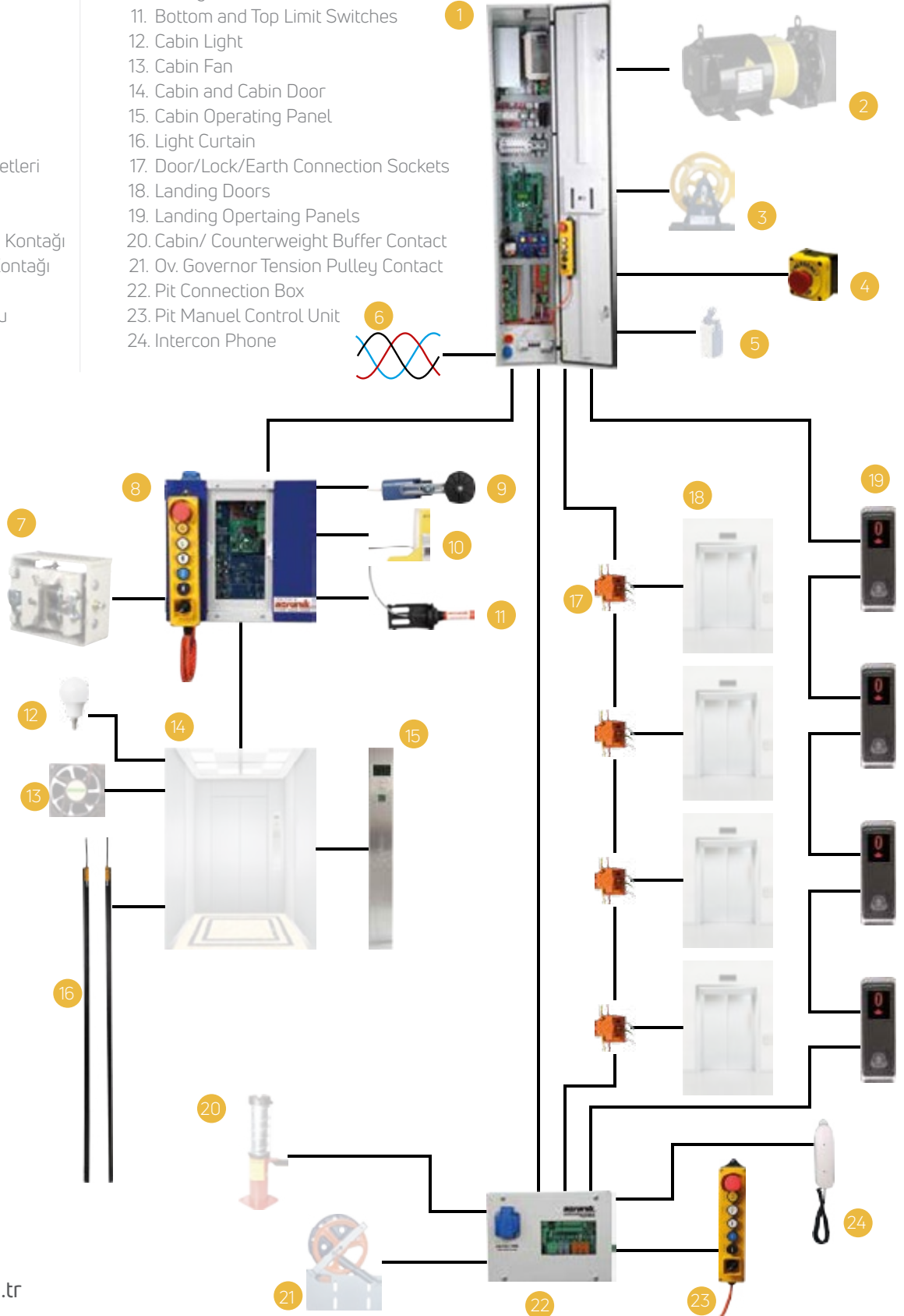

**Hız Kontrollü Kurtarıcılı Asansör
Kumanda Panosu**

VVVF Lift Control Panel with Rescue



**Makine Dairesiz Dişlisiz Asansör
Kumanda Panosu**

MRL Gearless Lift Control Panel

Arkel Arkode



Arkel ARL 300



LVF - 001



LVF - 002



LVF - 003



LVF - 004



LVF - 006



LVF - 007



LVF - 005



LVF - 008



LVF - 009



LVC - 001



LVC - 002



LVC - 003



LVC - 004



LVC - 005



LVC - 006



LVC - 007



LVF - 010

LVF - 011

LVF - 012



LVF - 013



LVF - 014



LVF - 015



LVC - 008

LVC - 009

LVC - 010

LVC - 011

LVC - 012

LVC - 013

LVC - 014



AKIŞ VOLPİ



AKIŞ CF 150



AKIŞ ZF82



AKAR DAK 125



ALBERTO SASSI MF94



ALBERTO SASSI LEO



AKAR SMT 255AC



AKIŞ AK03



ALBERTO SASSI G200 T1

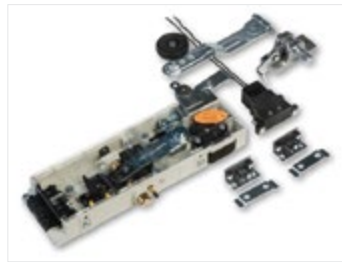
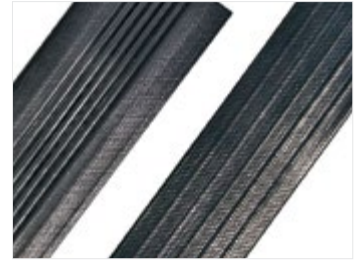







LV-001



LV-002



LV-003



LV-004



LV-005



LV-006



LV-007



LV-008



LV-009



LV-010



LV-011



LV-012



STAR GALAXY



KASHMIR WHITE



BLUE PEARL HQ



ABSOLUTE BLACK



AFRICAN IMP RED

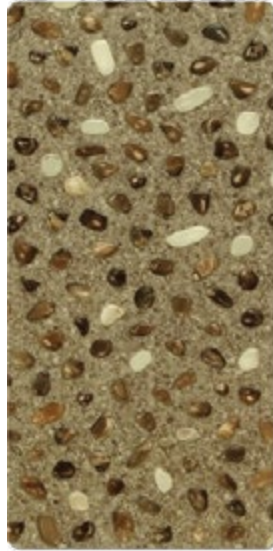

BROWN PVC



BLACK PVC



ROSA PORRINO



ROSA BETA



ALUMINUM



spirit customer's
organization

LIVALIFT

made

installation

working

increase

experienced

assurance

receives

employees

provide

support

after-sales

experience

understanding

customers

gain

project

superior

excellent

team production

based

continue

domestic

lifts principle

missions

achieve

ground

performance

Elevator

staff

quality

years

focus

needs

customer

young

Livalift ile Zirveye Çıkın !





LIVALIFT
— ASANSÖR —



Livalift Asansör

A: Kayacık Araplar Mah. Ali Ulvi Kurucu Cad. No:95 B
Karatay/KONYA

T: +90 332 238 48 29

F: +90 332 238 48 29

M: bilgi@livalift.com.tr

W: www.livalift.com.tr